

Edixeon[®] Series



Edixeon[®] series emitters are one of the highest flux LEDs in the world by Edison Opto. Edixeon[®] series emitters are designed to satisfy more and more Solid-State lighting High Power LED applications for brilliant world such as flash light, indoor and outdoor decoration light. Edixeon[®] series emitters are designed by particular package for High Power LED. 1W Edixeon[®] white has typical 70 lumens @350mA. Unlike most fluorescent sources, Edixeon[®] contains no mercury and has more energy efficient than other incandescent light source.

Features

- Various colors
- More energy efficient than incandescent and most halogen lamps
- Low voltage operation
- Instant light
- Long operating life

Table of Contents

Product Nomenclature	2
Environmental Compliance	3
LED Package Dimensions and Polarity	4
LED Package with Star Dimensions and Polarity.....	5
Absolute Maximum Ratings	6
Luminous Flux Characteristics	8
Forward Voltage Characteristics	10
JEDEC Information	11
Reliability Items and Failure Measures	12
Color Spectrum and Radiation Pattern.....	16
Optical & Electrical Characteristics	23
Product Soldering Instructions	29
Product Thermal Application Information	31
Product Electrical Application Information.....	36
Product Packaging Information	37
Star Product Packaging Information.....	39

Product Nomenclature

The following table describes the available color, power, and lens type. For more flux and forward voltage information, please consult the Bin Group document.

< Table 1 Edixeon® series nomenclature >

E D E W - 1 L A 1 - B 1- A B 16

X1		X2		X3		X4		X5		X6	
LED Item		Module		Emitting Color		Power		Lens Item		Housing Item	
Code	Type	Code	Type	Code	Type	Code	Type	Code	Type	Code	Type
ED	Edixeon®	E	Emitter	W	Cool White	1	1 W	L	Lambertian (140°)	A	White
		S	Star	H	Neutral White	3	3 W	B	Batwing (±40°)		
				X	Warm White			S	Side Emitting (±80°)		
				R	Red			F	Focusing (80°)		
				A	Amber						
				T	True Green						
				B	Blue						
				D	Dental Blue						
				C	Royal Blue						
				J	Cyan						

X7		X8		X9		X10		X11		X12	
Material		Phosphor Item		Testing Current		Shape Item		Al PCB Color		Thickness	
				Code	Type	Code	Type	Code	Type	Code	Type
				1	350mA	A	Star	W	White	10	1.0mm
				3	700mA	B	Square(25*25mm)	G	Green	16	1.6mm
						C	Square(30*30mm)	B	Black	20	2.0mm

Environmental Compliance

Edixeon[®] series are compliant to the Restriction of Hazardous Substances Directive or RoHS. The restricted materials including lead, mercury cadmium hexavalent chromium, polybrominated biphenyls (PBB) and polybrominated diphenyl ether (PBDE) are not used in Edixeon[®] series to provide an environmentally friendly product to the customers.

LED Package Dimensions and Polarity

Lambertian, Side Emitting, Batwing, and Focusing Emitter Type

Lambertian

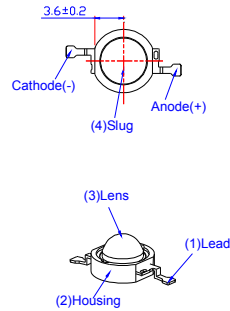
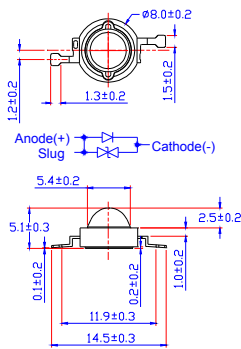

Side Emitting

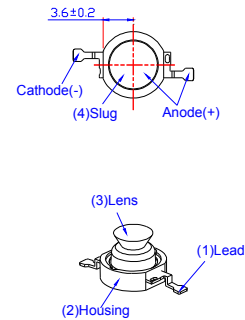
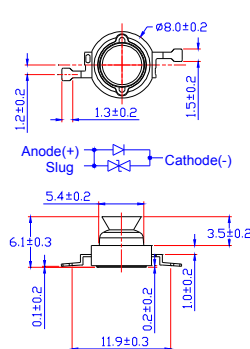

Batwing

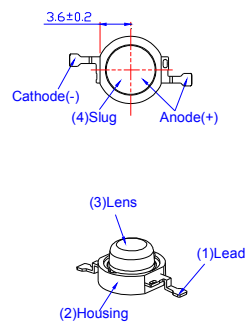
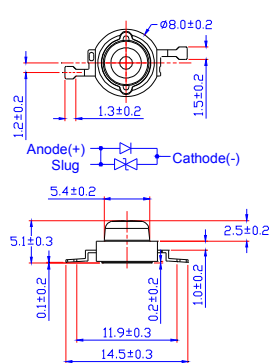

Focusing

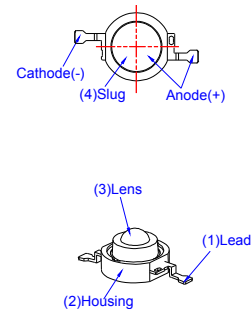
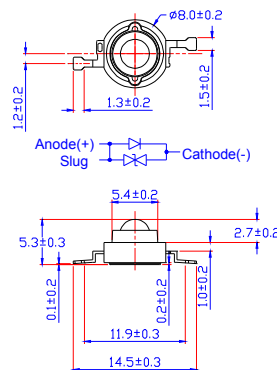

< Figure 1 Edixeon[®] series dimensions >

Notes:

1. All dimensions are in mm.
2. It is strongly recommended that the temperature of lead dose exceed 55°C .
3. Lambertian and side emitting series slug has polarity as anode.
4. It is important that the slug can't contact aluminum surface, It is strongly recommended that there should coat a uniform electrically isolated heat dissipation film on the aluminum surface.

LED Package with Star Dimensions and Polarity

EDSx-xxxx-AB16

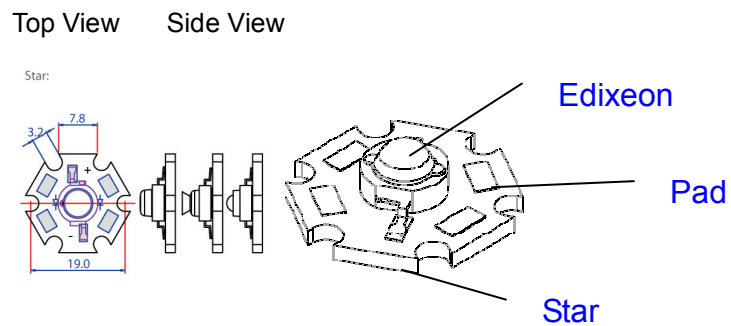

EDSx-xxxx-BB16

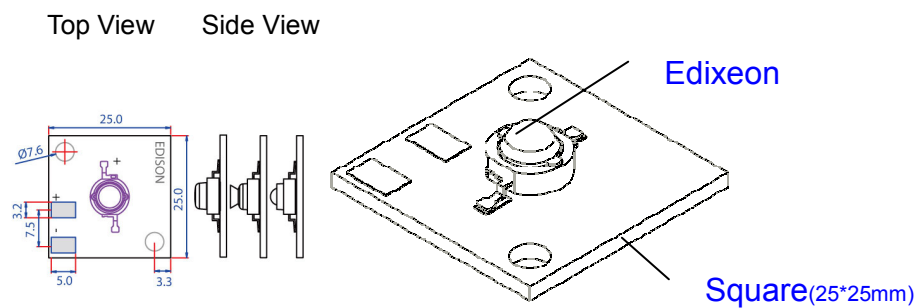

EDSx-xxxx-CB16

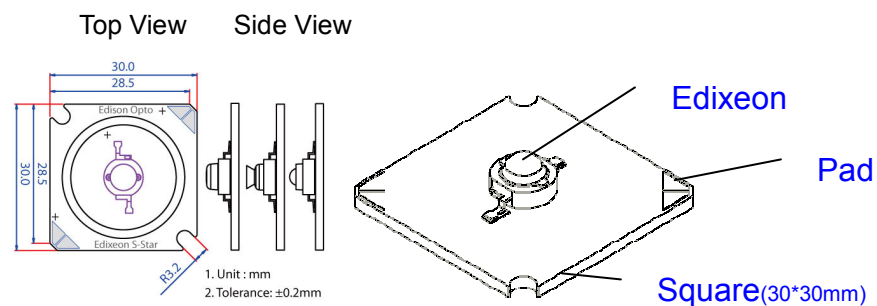

<Figure 2 Edixeon® star dimensions>

Notes:

1. All dimensions are in mm.
2. It is strongly recommended that the temperature of lead does not exceed 55°C

Absolute Maximum Ratings

The following tables describe flux of Edixeon[®] series under various current and different colors.

< Table 2 Absolute maximum ratings for Edixeon[®] series >

Parameter	Rating(1W)	Rating(3W)	Rating(5W)	Unit	Symbol
DC Forward Current	350	700	700	mA	I _F
Peak pulse current;(tp≤100μs, Duty cycle=0.25)	700	1,000	1,000	mA	
Reverse Voltage	5	5	9	V	V _R
Forward Voltage	5	5	9	V	V _F
LED junction Temperature (at DC Forward Current)	125	125	125	°C	T _J
Operating Temperature	-30 ~ +110	-30 ~ +110	-30 ~ +110	°C	
Storage Temperature	-40 ~ +120	-40 ~ +120	-40 ~ +120	°C	
ESD Sensitivity (Lambertian & Side Emitting)	4,000	4,000	500	V	
ESD Sensitivity (Red & Green)	--	500	--	V	
ESD Sensitivity (Batwing & Focusing)	500	--	--	V	
Manual Soldering Time at 260°C (Max.)	5	5	5	Sec.	

Notes:

1. Proper current derating must be observed to maintain junction temperature below the maximum at all time.
2. LEDs are not designed to be driven in reverse bias.
3. tp: Pulse width time

The following tables describe thermal resistance of Edixeon[®] series under various current and different colors

< Table 3 Temperature Coefficient of Forward Voltage & Thermal Resistance Junction to Case Characteristics at $T_J=25^{\circ}\text{C}$ for 1W Edixeon[®] series >

Lens Item	Part Name	Color	$\Delta V_F/\Delta T$		$R\theta_{J-B}$	
			Typ.	Unit	Typ.	Unit
Lambertian Side Emitting Batwing Focusing	EDEW-1xAx	Cool White	-2	mV/°C	15	°C/W
	EDEH-1xAx	Neutral White	-2	mV/°C	15	°C/W
	EDEX-1xAx	Warm White	-2	mV/°C	15	°C/W
	EDER-1xAx	Red	-2	mV/°C	15	°C/W
	EDEA-1xAx	Amber	-2	mV/°C	15	°C/W
	EDET-1xAx	True Green	-2	mV/°C	15	°C/W
	EDEJ-1xAx	Cyan	-2	mV/°C	15	°C/W
	EDEB-1xAx	Blue	-2	mV/°C	15	°C/W
	EDEC-1xAx	Royal Blue	-2	mV/°C	15	°C/W

< Table 4 Temperature Coefficient of Forward Voltage & Thermal Resistance Junction to Case Characteristics at $T_J=25^{\circ}\text{C}$ for 3W Edixeon[®] series >

Lens Item	Part Name	Color	$\Delta V_F/\Delta T$		$R\theta_{J-B}$	
			Typ.	Unit	Typ.	Unit
Lambertian	EDEW-3LA1-1	Cool White	-2	mV/°C	13	°C/W
	EDEH-3LA1-x3	Neutral White	-2	mV/°C	13	°C/W
	EDEX-3LA1-x3	Warm White	-2	mV/°C	13	°C/W
	EDER-3LA3	Red	-2	mV/°C	13	°C/W
	EDEA-3LA3	Amber	-2	mV/°C	13	°C/W
	EDET-3LA1	True Green	-2	mV/°C	13	°C/W
	EDEB-3LA1-1	Blue	-2	mV/°C	13	°C/W
	EDEC-3LA1-1	Royal Blue	-2	mV/°C	13	°C/W

Luminous Flux Characteristics

The following tables describe flux of Edixeon[®] series under various current and different colors

< Table 5 Luminous flux and Radiometric Power characteristics at $I_F=350\text{mA}$ and $T_J=25^\circ\text{C}$: for 1W Edixeon[®] series >

Lens Item	Part Name	Color	Flux/ Radiometric Power ^[1]			Unit
			Min.	Typ.	Max.	
Lambertian Side Emitting	EDEW-1xA1	Cool White	30.3	55.0	--	lm
	EDEW-1xA5	Cool White	30.3	70.0	--	lm
	EDEW-1xA6	Cool White	30.3	50.0	--	lm
	EDEH-1xA5-C1	Neutral White	30.3	50.0	--	lm
	EDEX-1xA5-C1	Warm White	30.3	40.0	--	lm
	EDER-1xA3	Red	23.3	40.0	--	lm
	EDEA-1xA3	Amber	23.3	40.0	--	lm
	EDET-1xA1	True Green	39.4	60.0	--	lm
	EDEJ-1xA1	Cyan	23.3	40.0	--	lm
	EDEB-1xA5	Blue	8.2	18.0	--	lm
	EDEC-1xA5	Royal Blue ^[1]	113.9	220	--	mW
Lens Item	Part Name	Color	Flux			Unit
			Min.	Typ.	Max.	
Batwing Focusing	EDEW-1xA5	Cool White	30.3	60.0	--	lm

< Table 6 Luminous flux and Radiometric Power characteristics at $I_F=700\text{mA}$ and $T_J=25^\circ\text{C}$: for 3W Edixeon[®] series >

Lens Item	Part Name	Color	Flux/ Radiometric Power ^[1]			Unit
			Min.	Typ.	Max.	
Lambertian	EDEW-3LA1-1	Cool White	86.5	120	--	lm
	EDEH-3LA1-C3	Neutral White	51.2	90	--	lm
	EDEX-3LA1-C3	Warm White	51.2	75	--	lm
	EDER-3LA3	Red	39.4	65	--	lm
	EDEA-3LA3	Amber	39.4	65	--	lm
	EDET-3LA1	True Green	51.2	110	--	lm
	EDEB-3LA1-1	Blue	13.8	30	--	lm
	EDEC-3LA1-1	Royal Blue ^[1]	256.3	350	--	mW

Notes:

1. Flux is measured with an accuracy of $\pm 10\%$
2. All cool white, neutral white, warm white, true green and blue emitters are built with InGaN
3. All red and amber emitters are built with AlGaInP
4. Blue power light source represented here is IEC60825 class 2 for eye safety.
5. Red and true green light source represented here are IEC60825 class 1 for eye safety.

Forward Voltage Characteristics

The following tables describe forward voltage of Edixeon® series under various current.

< Table 7 Forward voltage characteristics at $I_F=350\text{mA}$ and $T_J=25^\circ\text{C}$ for 1W Edixeon® series >

Lens Item	Part Name	Color	V_F		Unit
			Min.	Max.	
Lambertian Side Emitting Batwing Focusing	EDEW-1xA1	Cool White	3.1	4.0	V
	EDEW-1xA5	Cool White	3.1	4.0	V
	EDEW-1xA6	Cool White	3.1	4.3	V
	EDEH-1xA5-C1	Neutral White	3.1	4.0	V
	EDEX-1xA5-C1	Warm White	3.1	4.0	V
	EDER-1xA3	Red	2.0	3.0	V
	EDEA-1xA3	Amber	2.0	3.0	V
	EDET-1xA2	True Green	3.1	4.0	V
	EDEJ-1xA1	Cyan	3.1	4.0	V
	EDEB-1xA5	Blue	3.1	4.0	V
EDEC-1xA5	Royal Blue	3.1	4.0	V	

<Table 8 Forward voltage characteristics at $I_F=700\text{mA}$ and $T_J=25^\circ\text{C}$ for 3W Edixeon® series >

Lens Item	Part Name	Color	V_F		Unit
			Min.	Max.	
Lambertian	EDEW-3LA1-1	Cool White	3.1	4.3	V
	EDEH-3LA1-C3	Neutral White	3.1	4.3	V
	EDEX-3LA1-C3	Warm White	3.1	4.3	V
	EDER-3LA3	Red	2.0	3.0	V
	EDEA-3LA3	Amber	2.0	3.0	V
	EDET-3LA1	True Green	3.1	4.3	V
	EDEB-3LA1-1	Blue	3.1	4.3	V
	EDEC-3LA1-1	Royal Blue	3.1	4.3	V

Note:

1. Forward voltage is measured with an accuracy of $\pm 0.1\text{V}$

JEDEC Information

JEDEC is used to determine what classification level should be used for initial reliability qualification. Once identified, the LEDs can be properly packaged, stored and handled to avoid subsequent thermal and mechanical damage during the assembly solder attachment and/or repair operation. The present moisture sensitivity standard contains six levels, the lower the level, the longer the devices floor life. Edixeon[®] series are certified at level 4. This means Edixeon[®] series have a floor life of 72 hours before Edixeon[®] series need to re-baked.

< Table 9 JEDEC characteristics at T_J=25°C for Edixeon[®] series >

Level	Floor Life		Soak Requirements			
	Time	Conditions	Standard		Accelerated Environment	
			Time (hours)	Conditions	Time (hours)	Conditions
4	72hours	≤30°C / 60% RH	96 ¹ +5/-0	30°C / 60% RH	20 +0.5/-0	60°C / 60% RH

Level	Floor Life		Soak Requirements			
	Time	Condition	Standard		Accelerated Equivalent	
			Time(hours)	Condition	Time(hours)	Condition
1	Unlimited	≤30°C/85% RH	168 +5/-0	85°C/85% RH		
2	1 year	≤30°C/60% RH	168 +5/-0	85°C/60% RH		
2a	4 weeks	≤30°C/60% RH	696 ¹ +5/-0	30°C/60% RH	120 +1/-0	60°C/60% RH
3	168 hours	≤30°C/60% RH	192 ¹ +5/-0	30°C/60% RH	40 +5/-0	60°C/60% RH
4	72 hours	≤30°C/60% RH	96 ¹ +5/-0	30°C/60% RH	20 +5/-0	60°C/60% RH
5	48 hours	≤30°C/60% RH	72 ¹ +5/-0	30°C/60% RH	15 +5/-0	60°C/60% RH
5a	24 hours	≤30°C/60% RH	48 ¹ +5/-0	30°C/60% RH	10 +5/-0	60°C/60% RH
6	Time on tabel (TOL)	≤30°C/60% RH	TOL	30°C/60% RH		

Note:

1. The standard soak time includes a default value of 24 hours for semiconductor manufacturer's exposure time (MET) between bake and bag, and includes the maximum time allowed out of the bag at the distributor's facility.

Reliability Items and Failure Measures

Reliability test

The following table describes operating life, mechanical, and environmental tests performed on Edixeon® series package.

< Table 10 Operating life, mechanical, and environmental characteristics and $T_J=25^\circ\text{C}$ for Edixeon® series >

Stress Test	Stress Conditions	Stress Duration	Failure Criteria
Room Temperature Operating Life	25°C , $I_F = I_F \text{ Max DC}$ (Note 1)	1,000 hours	Note 2
High Temperature High Humidity	85°C / 85%RH	1,000 hours	Note 2
Temperature Cycle	$-40^\circ\text{C}/100^\circ\text{C}$,30 min dwell / <5min transfer	500 cycles	Note 2
High Temperature Storage Life	110°C	1,000 hours	Note 2
Low Temperature Storage Life	-40°C	1,000 hours	Note 2
Thermal Shock	$-40 / 125^\circ\text{C}$, 15 min dwell < 10 sec transfer	1,000 cycles	No catastrophics
Mechanical Shock	1500 G, 0.5 msec pulse, 5 shocks, each of 6 axis		No catastrophics
Natural Drop	On concrete from 1.2 m, 3X		No catastrophics
Variable Vibration Frequency	10-2000-10 Hz, log or linear sweep rate, 20 G about 1 min, 1.5 mm, 3X/axis		No catastrophics
Solder Heat Resistance (SHR)	$260^\circ\text{C} \pm 5^\circ\text{C}$, 10 sec		No catastrophics

Notes:

1. Depending on the maximum derating curve.
2. Failure Criteria:
 - Electrical failures
 - V_F shift $\geq 10\%$
 - Light Output Degradation
 - % I_v shift $\geq 30\%$ @1,000hrs or 200cycle
 - Visual failures
 - Broken or damaged package or lead
 - Solderability < 95% wetting
 - Dimensions out of tolerance

Failure Types

Catastrophic failures are failures that result in the LED emitting no light or very little light at normal current levels (e.g. 350 mA). Catastrophic failures are not expected for Edixeon® series that are handled and operated within the limits specified in Edixeon® documentation. Please refer to Absolute Maximum Ratings for more information on design limits.

Parametric failures are failures that cause key characteristics to shift outside of acceptable bounds. The most common parametric failure, for a high-power LED, is permanent light output degradation over operating life. Most other light sources experience catastrophic failure at the end of their useful life, providing a clear indication that the light source must be replaced. For instance, the filament of an incandescent light bulb breaks and the bulb ceases to create light. In contrast, high-power LEDs generally do not experience catastrophic failure but simply become too dim to be useful in the intended application. Further discussion of this matter can be found in the Long-Term Lumen Maintenance Testing section of this document. Another parametric failure common to white LEDs is a large and permanent shift in the exact color of white light output, called the white point or color point. A shift in white point may not be detectable in one LED by itself, but would be obvious in a side-by-side comparison of multiple LEDs. Since each lighting installation commonly uses many high-power LEDs, white point stability is a point of concern for lighting designers. Typically, white high-power LEDs, created by combining blue LEDs with yellow (and sometimes red) phosphor, will shift towards blue over operational life. This shift can be accelerated by high temperatures and high drive currents. For example, a cool white (e.g., 6500K CCT) LED with a white point failure will typically appear light blue instead of white. In some high-power LEDs, this failure mode can occur after just 1,000 hours of operational life.

Just as with fluorescent light sources, all white high-power LEDs will experience shifts in white point over their operating lives. It is possible for the design of the phosphor and packaging systems to minimize these shifts and contain the shifts to be less than what is detectable by the human eye. As with catastrophic failures, parametric failures can be minimized by adhering to limits specified in Edixeon® documentation.

The MTBF of Edixeon® series

Mean time between failures (MTBF) is the mean (average) time between failures of a system, the reciprocal of the failure rate in the special case when the failure rate is constant. Calculations of MTBF assume that a system is "renewed", i.e. fixed, after each failure, and then returned to service immediately after failure. A related term, mean distance between failures, with a similar and more intuitive sense, is widely

used in transport industries such as railways and trucking. The average time between failing and being returned to service is termed mean down time (MDT).

The formula of MTBF for Edixeon® series can be

$$\log(\text{Life}) = \frac{1,600}{T_J(^{\circ}\text{C}) + 273}$$

< Table 11 Relation between Junction Temperature and Life time >

$T_J (^{\circ}\text{C})$	Life (hours)	$T_J (^{\circ}\text{C})$	Life (hours)
25	234,000	85	29,500
30	191,000	90	25,700
35	157,000	95	22,300
40	129,000	100	19,500
45	107,000	105	17,100
50	90,000	110	15,100
55	75,000	115	13,300
60	64,000	120	11,700
65	54,000	125	10,500
70	46,000	130	9,300
75	39,600	140	7,500
80	34,000	150	6,000

Note:

1. Life means the time when light output decay to 70%

The MTTF of Edixeon® emitters

An estimate of the average, or mean time until a design's or component's first failure, or disruption in the operation of the product, process, procedure, or design occurs.

Mean time until a failure assumes that the product CAN NOT be repaired and the product CAN NOT resume any of its normal operations.

Mean time to failure (MTTF) is related to items such as expected and/or operating life or other items that in general are not fixed or replacement even though it sometimes may be.

MTTF is assumed to be 100,000,000

The failure rates at different hours and different systems (LED quantity) are as below:

if there is 1 failure of 1 emitter in a system

$T_J = 75^{\circ}\text{C}$ is giving 0.01% (100ppm) at 10,000hrs

if there is 1 failure of 10 emitters in a system

$T_j=75^{\circ}\text{C}$ is giving 0.1%(1,000ppm) at 10,000hrs
if there is 1 failure of 1 emitter in a system

$T_j=75^{\circ}\text{C}$ is giving 0.05%(500ppm) at 50,000hrs
if there is 1 failure of 10 emitters in a system

$T_j=75^{\circ}\text{C}$ is giving 0.5%(5,000ppm) at 50,000hrs.

ASSIST FORM for high power LED reliability(Ex: Edixeon® series @350mA)

< Table 12 Different junction temperature characteristics >

	$T_s=45^{\circ}\text{C}$	$T_s=65^{\circ}\text{C}$	$T_s=85^{\circ}\text{C}$
Voltage	3.5V	3.5V	3.5V
Current	350mA	350mA	350mA
Wattage	1.2W	1.2W	1.2W
Heat	0.92W	0.92W	0.92W
Rth	15 °C/W	15 °C/W	15 °C/W
T_j	60 °C	80 °C	100 °C
$L_{70\%}$	64,000hrs	34,000hrs	19,500hrs

Notes:

1. T_s : slug temperature
2. ASSIST. Alliance for Solid-State Illumonaton Systems and Technonlgies

Color Spectrum and Radiation Pattern

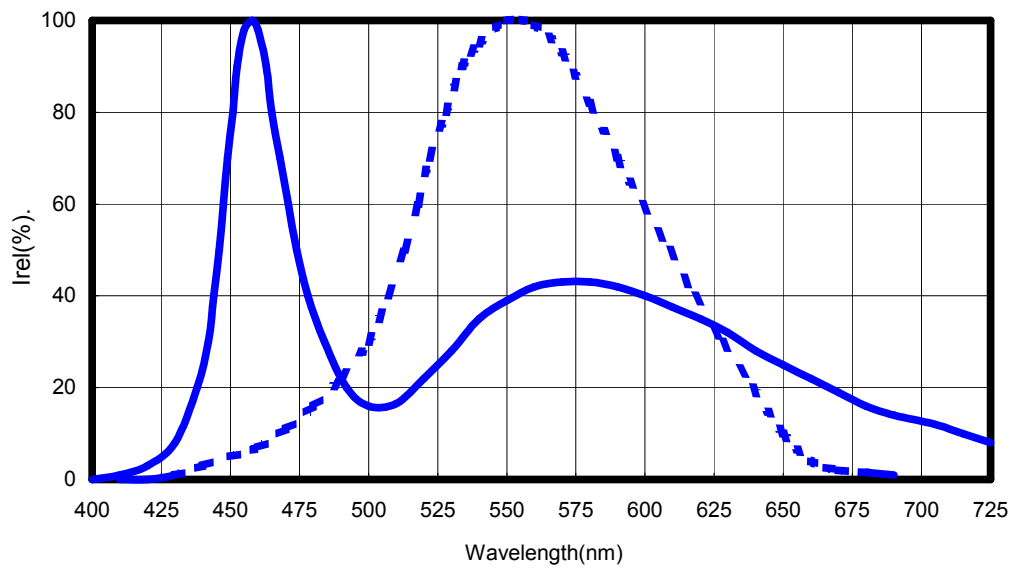

<Figure 3 Cool white color spectrum at $T_j = 25^\circ\text{C}$.for Edixeon[®] series >

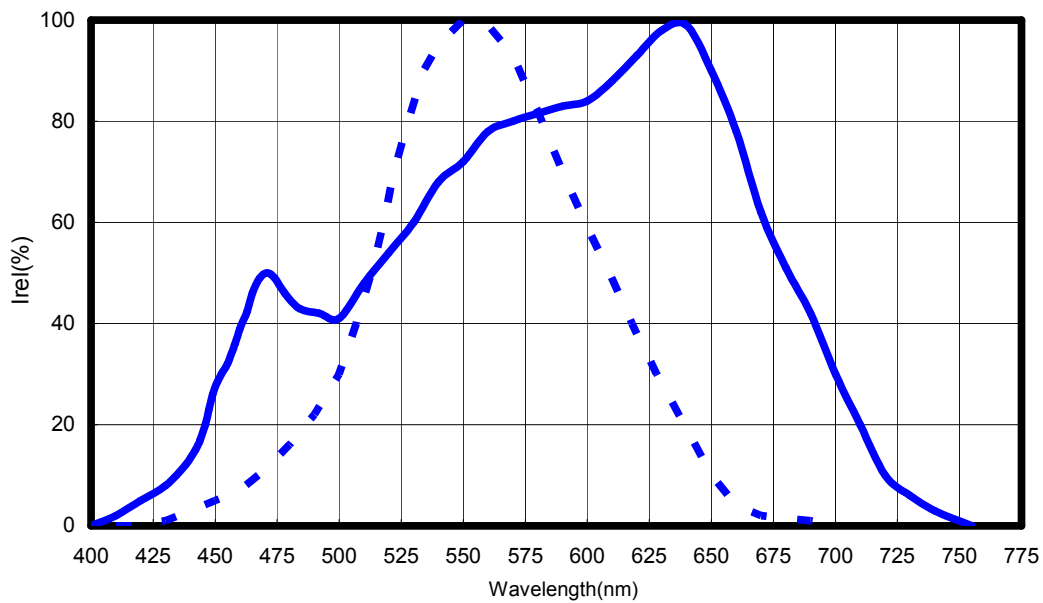

< Figure 4 Neutral white and warm white color spectrum at $T_j = 25^\circ\text{C}$.for Edixeon[®] series >

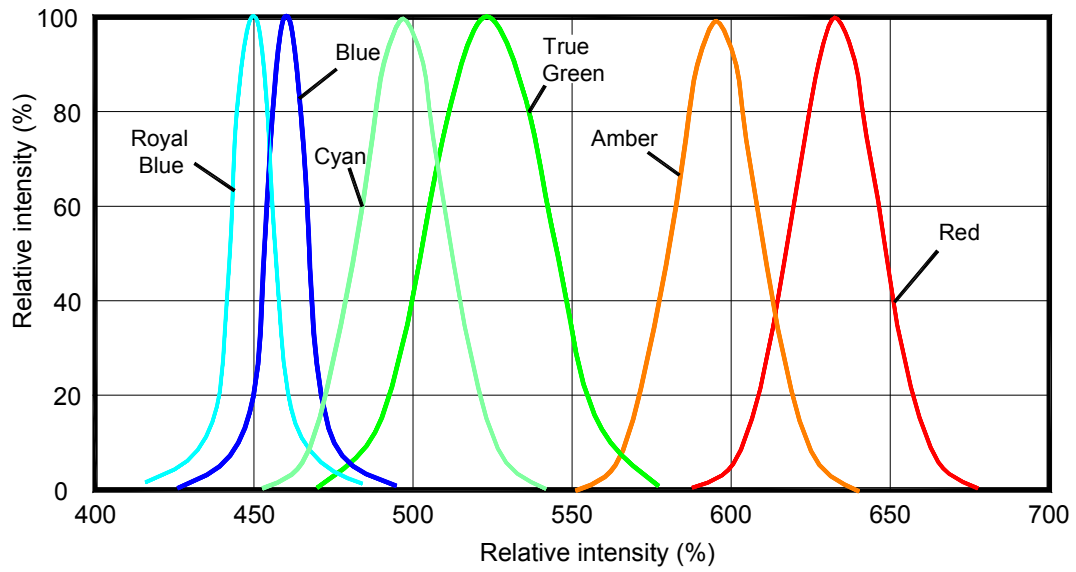

< Figure 5 Red, amber, true green, cyan, blue, dental blue, and royal blue color spectrum at $T_j = 25^\circ\text{C}$.for Edixeon[®] series >

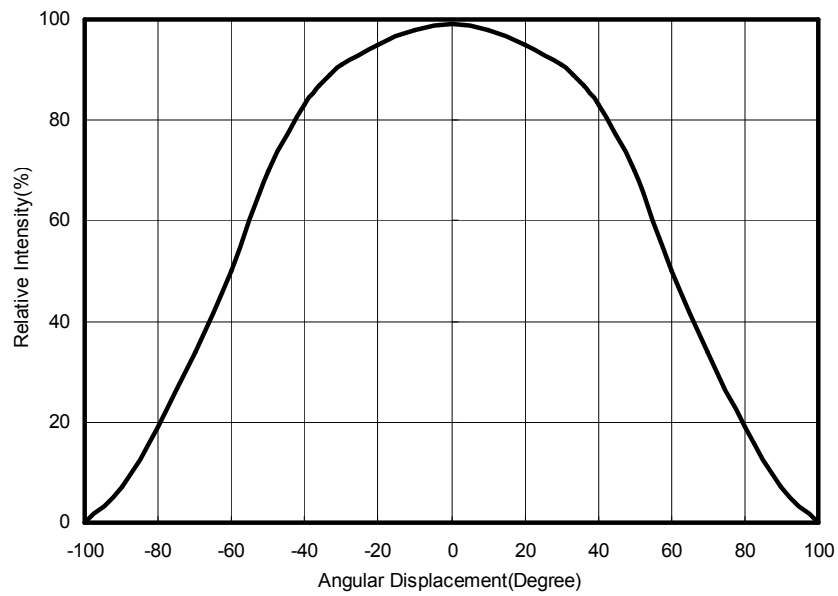

< Figure 6.Lambertain at $T_j = 25^\circ\text{C}$ for red and amber >

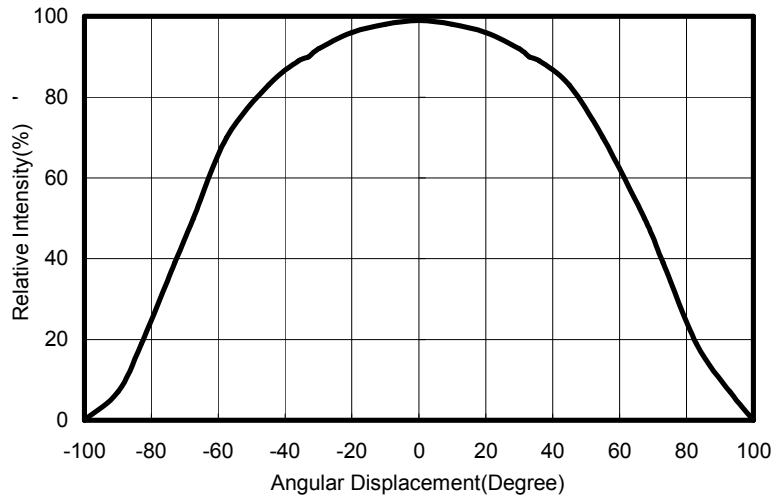

< Figure 7.Lambertain at $T_J=25^{\circ}\text{C}$ for cool white, neutral white, and warm white >

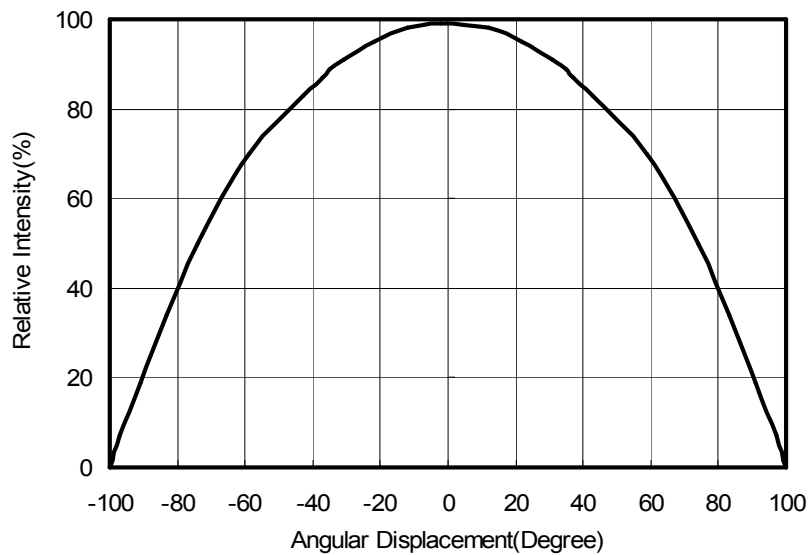

< Figure 8.Lambertain at $T_J=25^{\circ}\text{C}$ for blue, dental blue, royal blue, cyan, and true green >

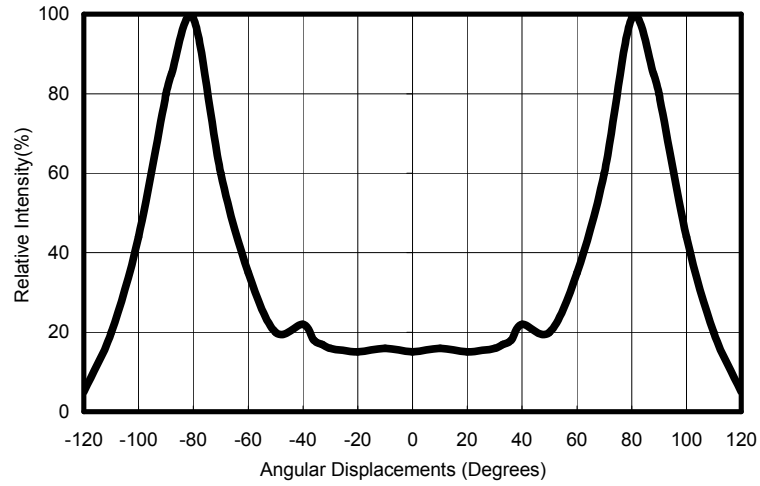

<Figure 9.Side emitting at $T_j=25^{\circ}\text{C}$ for all color.>

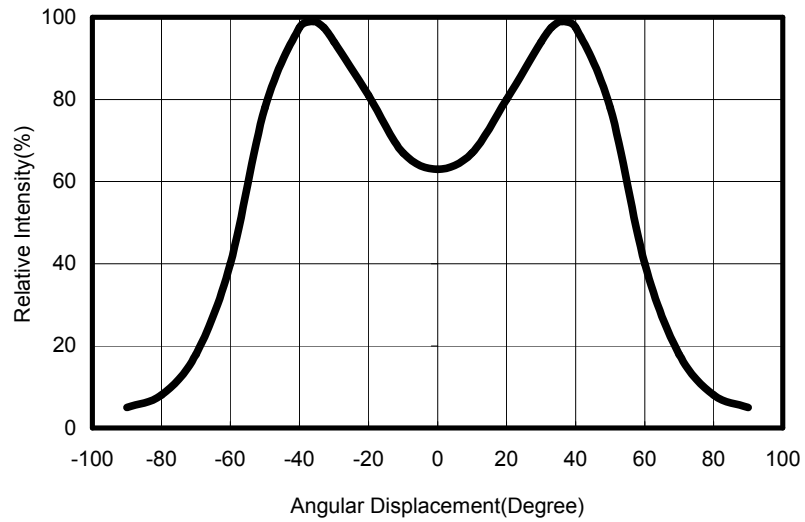

<Figure 10.Batwing at $T_j=25^{\circ}\text{C}$ for cool white.>

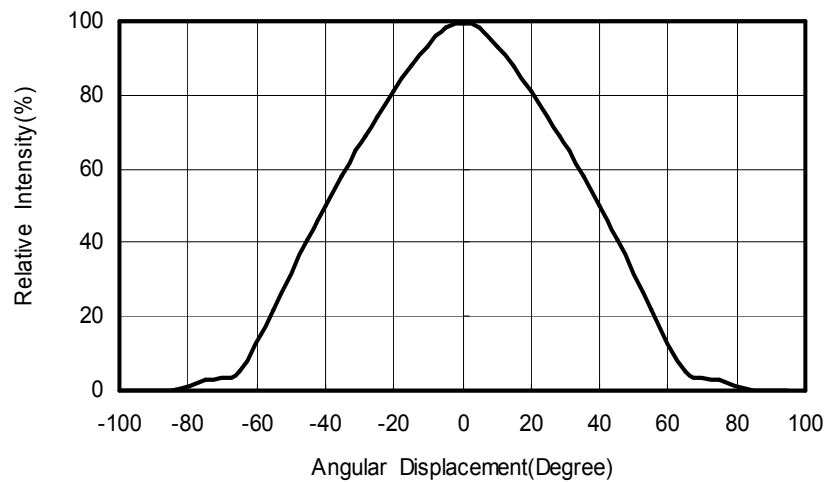

<Figure 11.Focusing at $T_j=25^{\circ}\text{C}$ for cool white.>

Color Temperature or Dominant Wavelength Characteristics $T_J=25^\circ\text{C}$

< Table 13 Dominant wavelength , peak wavelength or color temperature characteristics at $T_J=25^\circ\text{C}$ for 1W Edixeon[®] series >

Lens Item	Part Name	Color	λ_d/λ_p /CCT		Unit
			Min.	Max.	
	EDEW-1xAx	Cool White	5,000	10,000	K
	EDEH-1xAx	Neutral White	3,800	5,000	K
	EDEX-1xAx	Warm White	2,670	3,800	K
Lambertian Side Emitting Batwing Focusing	EDER-1xAx	Red	620	630	nm
	EDEA-1xAx	Amber	585	595	nm
	EDET-1xAx	True Green	515	535	nm
	EDEJ-1xAx	Cyan	490	510	nm
	EDEB-1xAx	Blue	460	475	nm
	EDEC-1xAx	Royal Blue	440	460	nm

Notes:

1. Wavelength is measured with an accuracy of $\pm 0.5\text{nm}$
2. CCT is measured with an accuracy of $\pm 200\text{K}$

< Table 14 Dominant wavelength , peak wavelength or color temperature characteristics at $T_J=25^\circ\text{C}$ for 3W Edixeon[®] series >

Lens Item	Part Name	Color	λ_d/λ_p /CCT		Unit
			Min.	Max.	
	EDEW-3LA1-1	Cool White	5,000	10,000	K
	EDEH-3LA1-C3	Neutral White	3,800	5,000	K
	EDEX-3LA1-C3	Warm White	2,670	3,800	K
Lambertian	EDER-3LA3	Red	620	630	nm
	EDEA-3LA3	Amber	585	595	nm
	EDET-3LA1	True Green	515	535	nm
	EDEB-3LA1-1	Blue	460	475	nm
	EDEC-3LA1-1	Royal Blue	440	460	nm

Notes:

1. Wavelength is measured with an accuracy of $\pm 0.5\text{nm}$
2. CCT is measured with an accuracy of $\pm 200\text{K}$

Emission Angle Characteristics

< Table 15 Emission angle characteristics at $T_J = 25^\circ\text{C}$ for 1W Edixeon[®] series >

Part Name	Color	$2\theta^{1/2}(\text{Typ.})$			Unit
		Lambertian	Batwing	Focusing	
EDEW-1xAx	Cool White	135	110	80	Deg.
EDEH-1LAx	Neutral White	135	--	--	Deg.
EDEX-1LAx	Warm White	135	--	--	Deg.
EDER-1LA3	Red	120	--	--	Deg.
EDEA-1LA3	Amber	120	--	--	Deg.
EDET-1LA2	True Green	150	--	--	Deg.
EDEJ-1LA1	Cyan	150	--	--	Deg.
EDEB-1LAx	Blue	150	--	--	Deg.
EDED-1LAx	Dental Blue	150	--	--	Deg.
EDEC-1LAx	Royal Blue	150	--	--	Deg.

Part Name	Color	$\theta_{\text{PEAK}}(\text{Typ.})$		Unit
		Batwing	Side emitting	
EDEW-1xAx	Cool White	± 40	± 80	Deg.

< Table 16 Emission angle characteristics at $T_J = 25^\circ\text{C}$ for 3W Edixeon[®] series >

Part Name	Color	$2\theta^{1/2}$			Unit
		Max.	Typ.	Min.	
EDEW-3LA1-1	Cool White	--	135	--	Deg.
EDEH-3LA1-C3	Neutral White	--	135	--	Deg.
EDEX-3LA1-C3	Warm White	--	135	--	Deg.
EDER-3LA3	Red	--	120	--	Deg.
EDEA-3LA3	Amber	--	120	--	Deg.
EDET-3LA1	True Green	--	150	--	Deg.
EDEB-3LA1-1	Blue	--	150	--	Deg.
EDED-3LA1-1	Dental Blue	--	150	--	Deg.
EDEC-3LA1-1	Royal Blue	--	150	--	Deg.

< Table 17 Emission angle characteristics at Tj=25°C for 5W Edixeon® series >

Part Name	Color	2θ ^{1/2}			Unit
		Min.	Typ.	Max.	
EDEW-5LA6	Cool White	--	135	--	Deg.
EDEH-5LA6	Neutral White	--	135	--	Deg.
EDEX-5LA6	Warm White	--	135	--	Deg.
EDEB-5LA6	Blue	--	150	--	Deg.
EDED-5LA6	Royal Blue	--	150	--	Deg.
EDEB-5LA6	Blue	--	150	--	Deg.

Optical & Electrical Characteristics

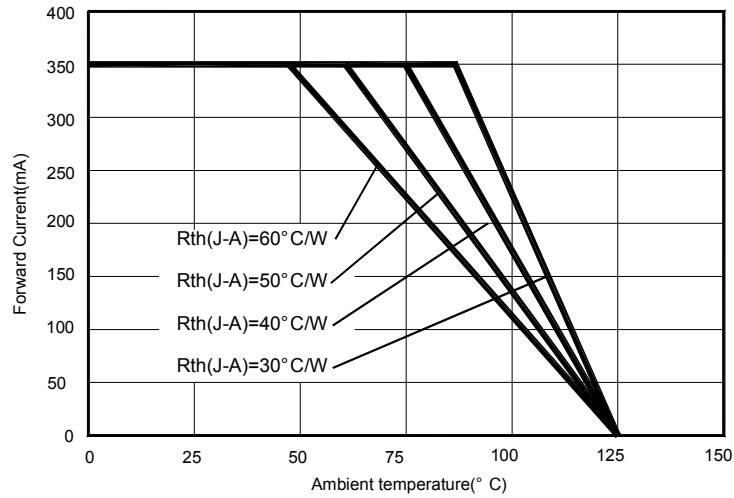

< Figure 12. Operating current & ambient temperature for 1W Edixeon[®] series >

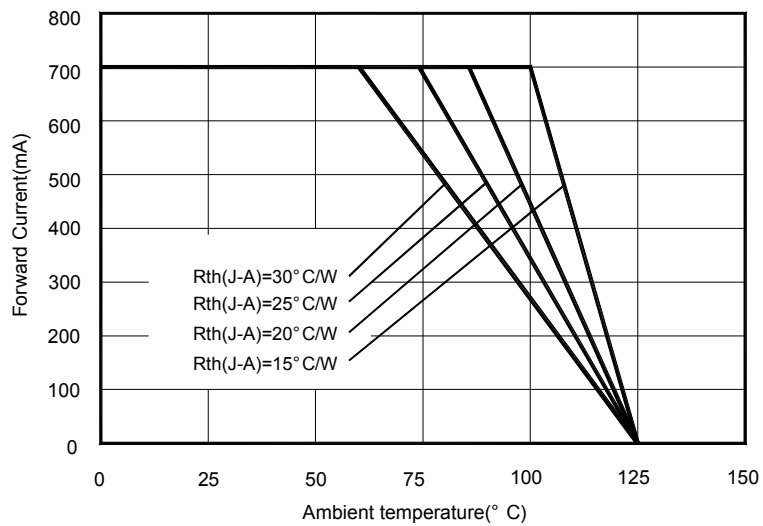

< Figure 13. Operating current & ambient temperature for 3W/5W Edixeon[®] series >

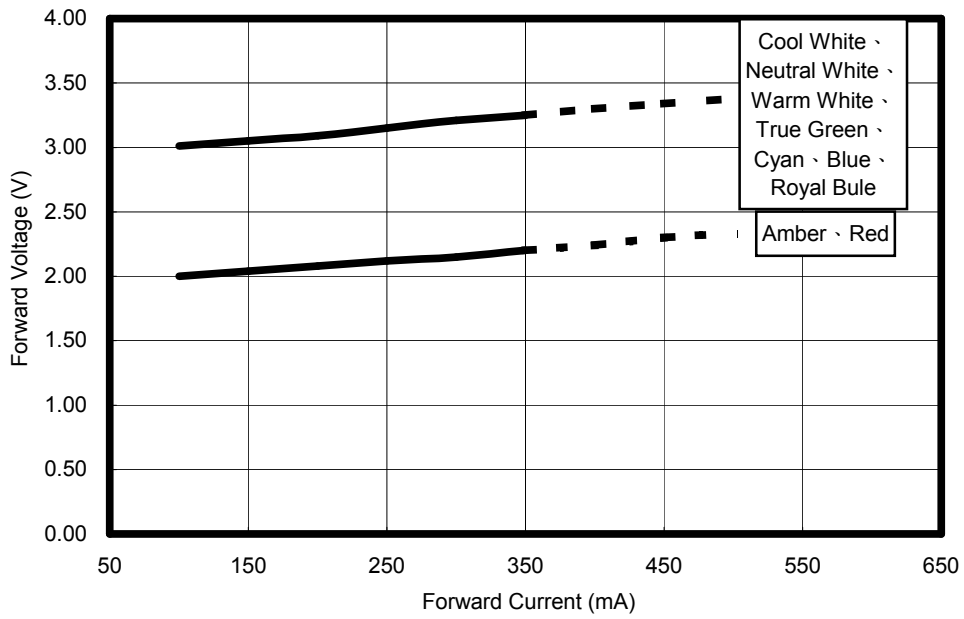

< Figure 14. Forward current & forward voltage for 1W Edixeon® series >

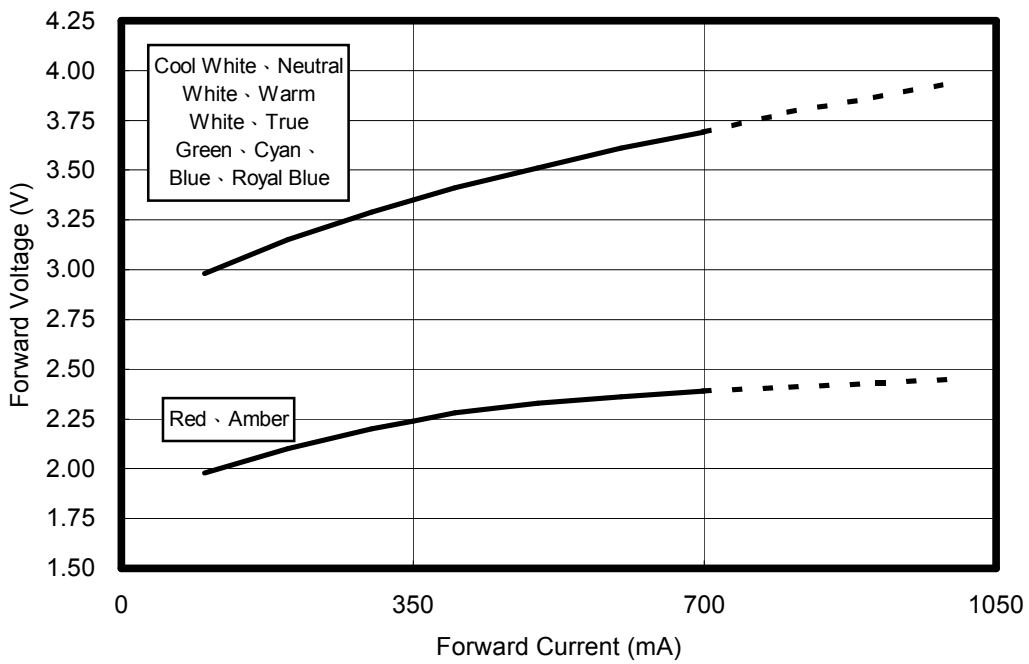

< Figure 15. Forward current & forward voltage for 3W Edixeon® series >

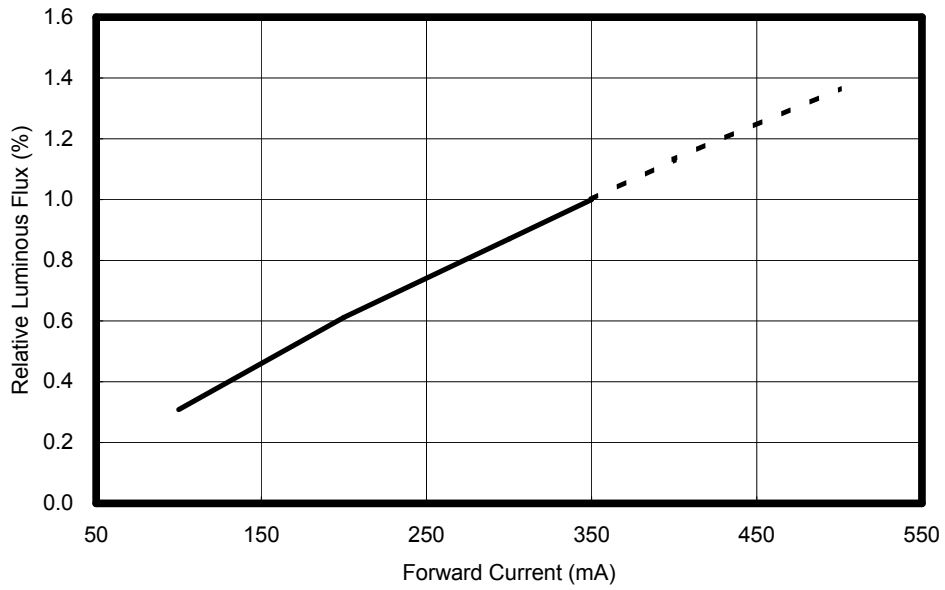

< Figure 16. Forward current & relative luminous at $T_J=25^\circ\text{C}$ for 1W Edixeon[®] series >

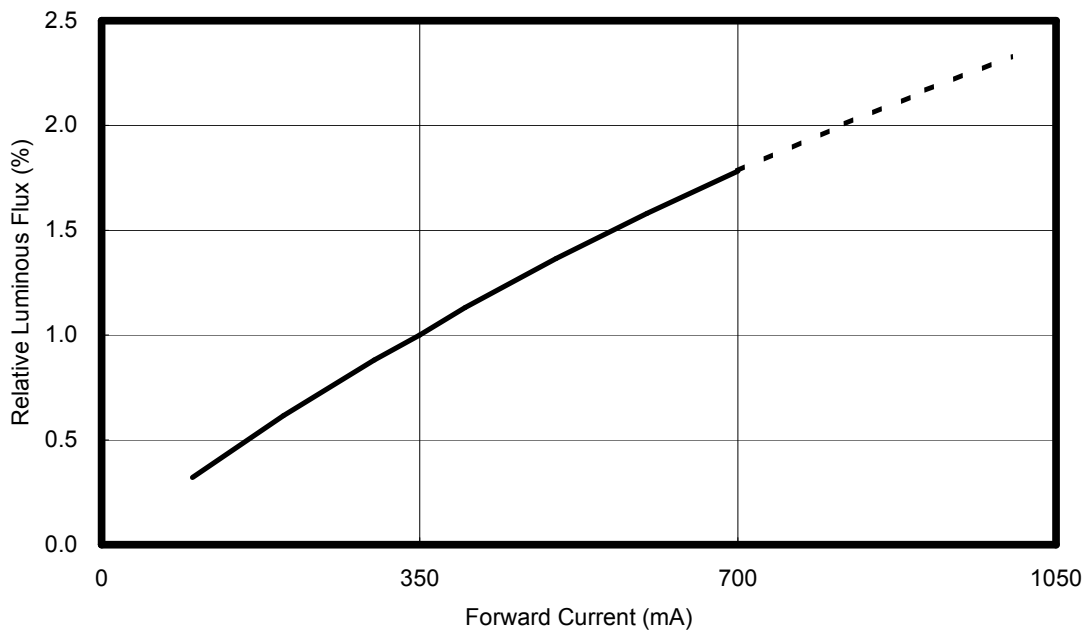

< Figure 17. Forward current & relative luminous at $T_J=25^\circ\text{C}$ for 3W Edixeon[®] series >

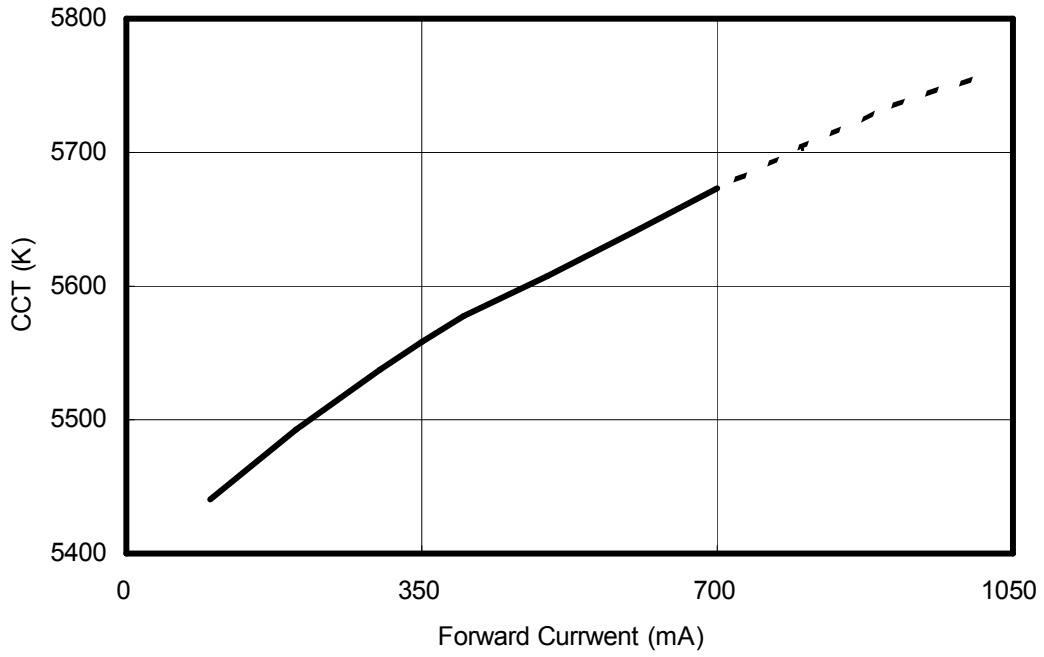

< Figure 18. Forward current & CCT at $T_J = 25^\circ\text{C}$ for Edixeon[®] series cool white >

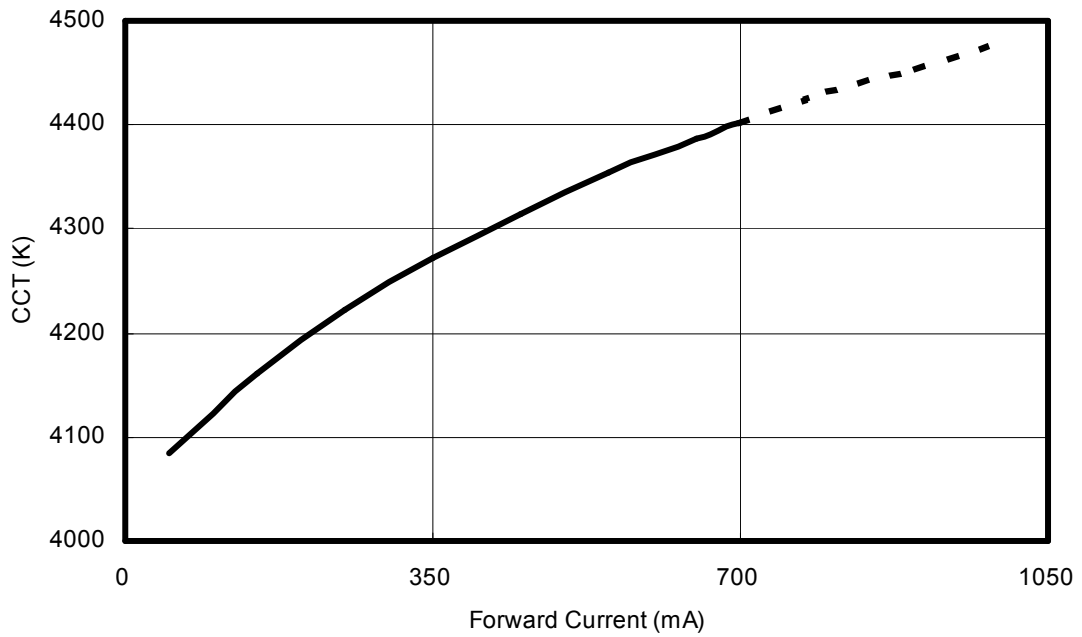

< Figure 19. Forward current & CCT at $T_J = 25^\circ\text{C}$ for Edixeon[®] series neutral white >

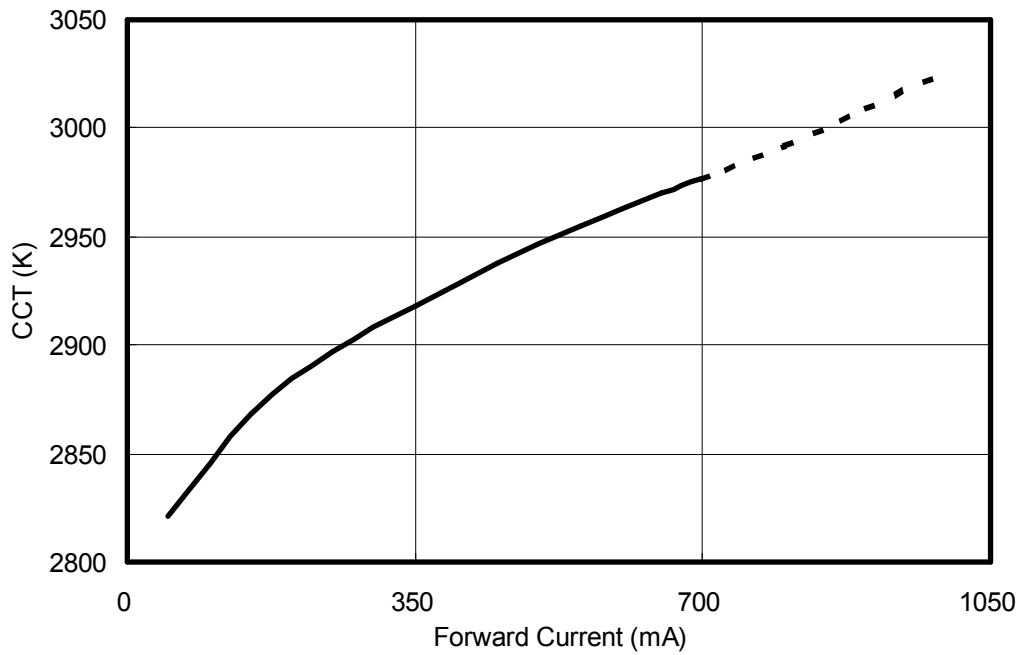

< Figure 20. Forward current & CCT at $T_j=25^\circ\text{C}$ for Edixeon[®] series warm white >

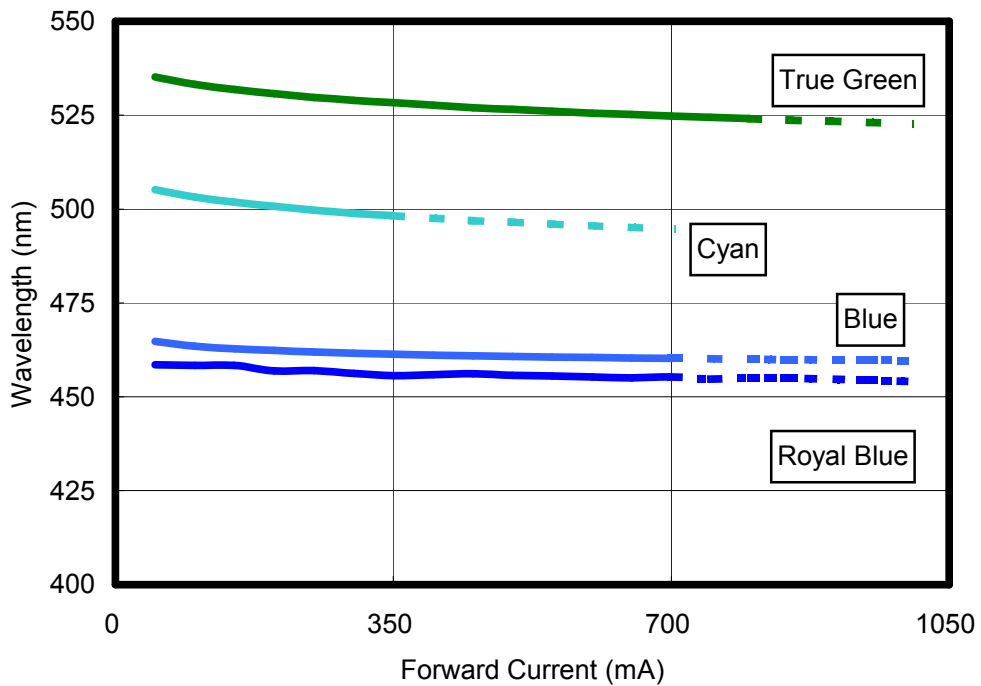

< Figure 21. Forward current & wavelength at $T_j=25^\circ\text{C}$ for Edixeon[®] series true green, blue, and royal blue >

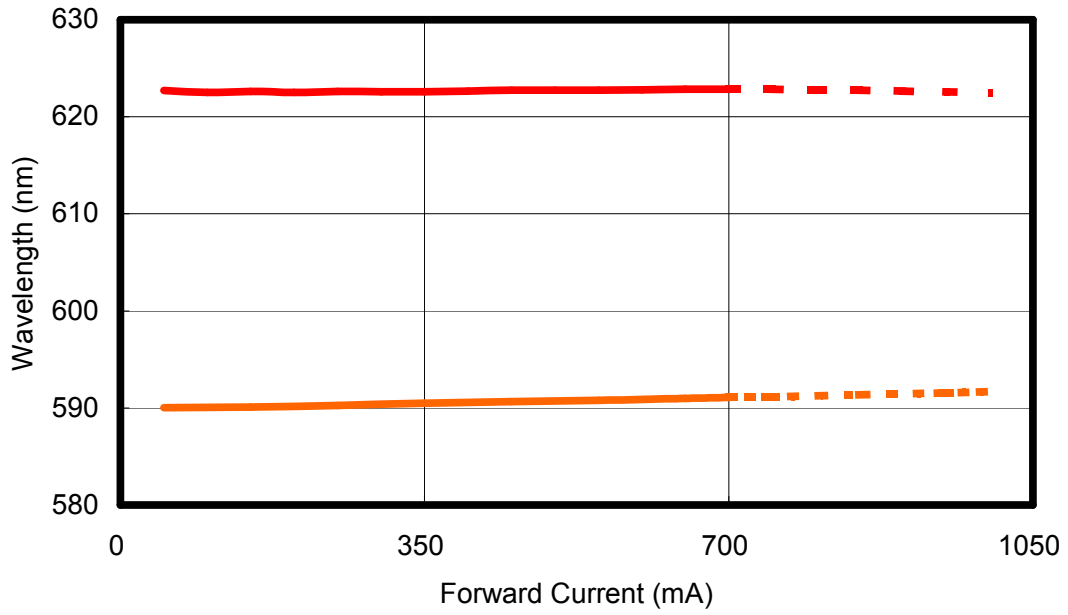

< Figure 22. Forward current & wavelength at $T_J=25^{\circ}\text{C}$ for Edixeon[®] series red and amber >

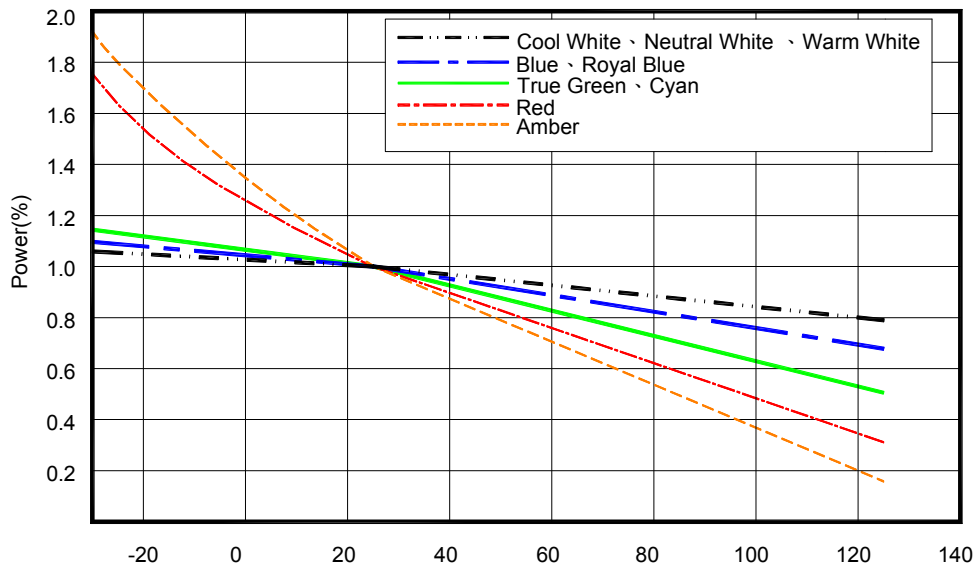

< Figure 23. Junction temperature & power rate for Edixeon[®] series >

Product Soldering Instructions

The central circle pad at the bottom face of the package provides the main path for heat dissipation from the LED to the heat sink (heat sink contact).

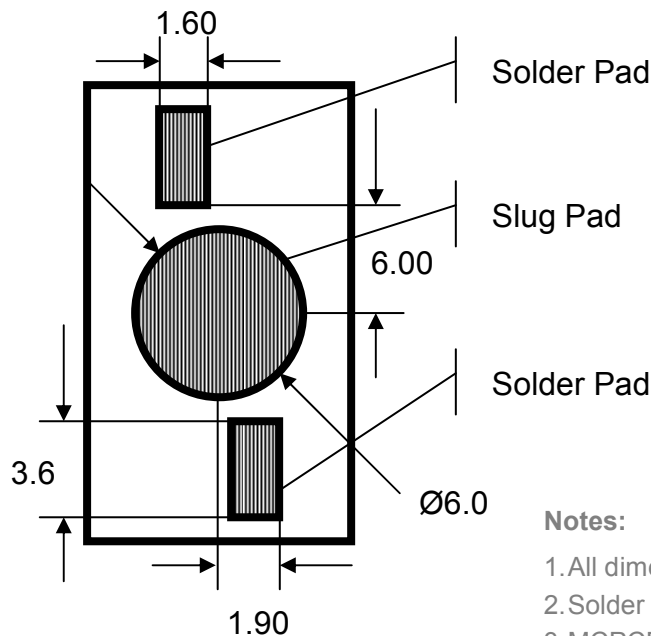

<Figure 24.Pad dimensions>

Notes:

1. All dimensions are measured in mm.
2. Solder pad cannot be connected to slug pad.
3. MCPCB material with a thermal conductivity greater than 3.0 W/mK.
4. Please avoid touching the Edixeon[®] lens during assembly processes. This may cause pollution or scratch on the surface of lens.
5. Edixeon[®] series can not be heated over 150°C.

The choice of solder and the application method will dictate the specific amount of solder. For most consistent results, an automated dispensing system or a solder stencil printer is recommended.

Positive results will be used solder thickness that results in 50µm. The lamp can be placed on the PCB simultaneously with any other required SMD devices and reflow completed in a single step. Automated pick-and-place tools are recommended.

The central slug at the bottom face of the package provides the main path for heat dissipation from the LED to the heat sink (heat sink contact). A key feature of Edixeon[®] series is an electrically neutral heat path that is separate from the LED's electrical contacts. This electrically isolated thermal pad makes Edixeon[®] series perfect for use with either FR4 circuit boards with thermal via or with metal-core printed circuit boards (MCPCB).

Recommend Solder Steps

To prevent mechanical failure of LEDs in the soldering process, a carefully controlled pre-heat and post-cooling sequence is necessary. The heating rate in an IR furnace depends on the absorption coefficients of the material surfaces and on the ratio of the component's mass to its irradiated surface. The temperature of parts in an IR furnace, with a mixture of radiation and convection, cannot be determined in advance.

Temperature measurement may be performed by measuring the temperature of a specific component while it is being transported through the furnace. Influencing parameters on the internal temperature of the component are as follows:

- Time and power
- Mass of the component (for Edixeon[®] series on MCPCB)
- Size of the component
- Size of the printed circuit board
- Absorption coefficient of the surfaces and MCPCB
- Packing density

Peak temperatures can vary greatly across the PC board during IR processes. The variables that contribute to this wide temperature range include the furnace type and the size, mass and relative location of the components on the board. Profiles must be carefully tested to determine the hottest and coolest points on the board. The hottest and coolest points should fall within the recommended temperatures. The profile of the reflow system should be based on design needs, the selected solder system and the solder-paste manufacturer's recommended reflow profile.

Product Thermal Application Information

Thermal grease should be evenly spreaded with a thickness <math><100\mu\text{m}</math>.

When assembling on MCPCB or heat sink carrier.

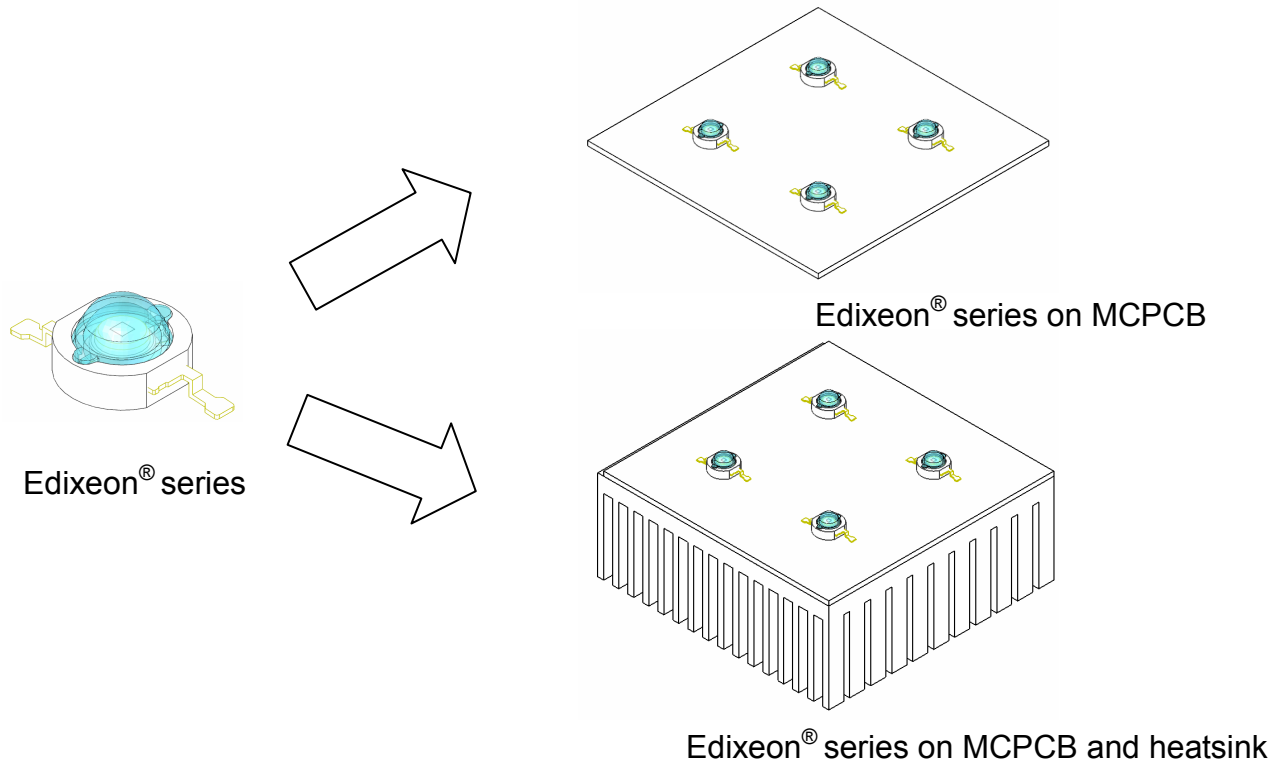

< Figure 25. Edixeon® series heatsink application >

—It is strongly recommended the heat sink should be anodized.

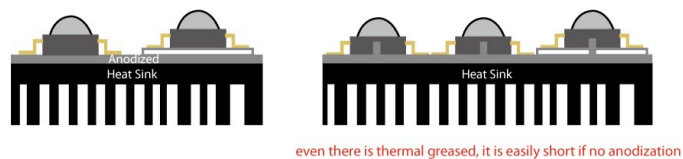

—Please ensure the heat sink is flat enough to prevent the bad heat conductivity.



< Figure 26. Edixeon® series assemble with heatsink >

Thermal Resistance Application

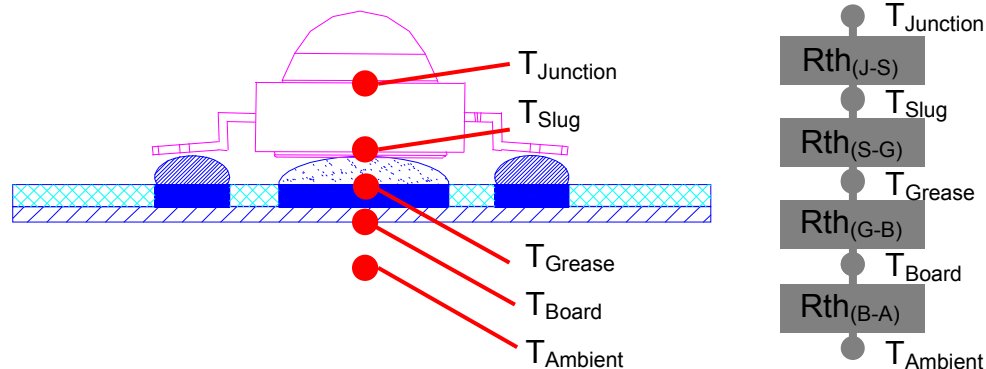

$$R_{th(J-A)} = R_{th(J-S)} + R_{th(S-G)} + R_{th(G-B)} + R_{th(B-A)}$$

$$T_{Junction} = T_{Ambient} + R_{th(J-A)} \times P_{Dissipation}$$

$$(T_J = T_A + R_{th(J-A)} \times P_{Dissipation})$$

<Figure 27. Rth and T_J for Edixeon >

Suggested Adhesive for Selection(such as thermal grease)

- Ease of use
 - Non-solvent, One-part
- Fast tack free
 - 3 minutes at 25°C
- No corrosion
 - Alcohol type of room temperature vulcanization (RTV)
- Low volatility
 - Low weight loss of silicone volatiles
- Adhesion
 - Excellent adhesion to most materials without use of a primer
- Dielectric properties
 - Cured rubber exhibits good dielectric properties
- Excellent thermal stability and cold resistance
 - Cured rubber provides wide service temperature range

<Table 18 Specification for Adhesive properties >

Specification	Suggested Properties
Take-free time	3~10 minutes
Specific gravity	< 3 g/cm ²
Thermal conductivity	> 2.5 W/mK
Rth in using	< 1.8 °C/W
Volume resistance	> 1x10 ¹⁴
Lap shear adhesion strength	> 200 N/ cm ²
Tensile strength	> 4 Mpa

Thermal Resistance Calculation

The thermal resistance between two points is defined as the ratio of the difference in temperature to the power dissipated. For calculations in the following units used are °C/W. In the case of LEDs, the resistance of two important thermal paths affects the junction temperature:

From the LED junction to the thermal contact at the bottom of the package, this thermal resistance is governed by the package design. It is referred to as the thermal resistance between junction and slug ($R_{th (J-S)}$)

From the thermal contact to ambient conditions, this thermal resistance is defined by the path between the slug ,board ,and ambient. It is referred to as the thermal resistance between slug and board ($R_{th (S-B)}$) and between board and ambient ($R_{th (B-A)}$).

The overall thermal resistance between the LED junction and ambient ($R_{th (J-A)}$) can be modeled as the sum of the series resistances $R_{th (J-S)}$, $R_{th (S-B)}$, and $R_{th (B-A)}$.

The following will show how to calculate R_{th} for each part of LED module.

1. $R_{th(J-S)}$

Assume Edixeon® $R_{th(J-S)}=10\text{ }^{\circ}\text{C/W}$

2. $R_{th(S-G)}$

If the thickness of thermal grease is 100um and area is $(6.4/2)^2\pi\text{ mm}^2$.

Thermal conductivity of thermal grease is 2.6 W/mK.

The Formula of R_{th} is
$$\frac{\text{Thickness(um)}}{\text{Thermal Conductivity (W/mK) x Area(mm}^2\text{)}}$$

Therefore $R_{th(S-G)} = \frac{100}{2.6 \times (6.4/2)^2\pi} = 1.2\text{ }^{\circ}\text{C/W}$

3. $R_{th(G-B)}$

The R_{th} of standard MCPCB is $1.5\text{ }^{\circ}\text{C/W}$

4. $R_{th(B-A)}$

The R_{th} between board and air is mainly dependent on the total surface area.

$$\text{Therefore } R_{th(B-A)} \doteq \frac{500}{\text{Area}(\text{cm})^2}$$

$$\text{If Area is } 30\text{cm}^2 \quad R_{th}=16.7 \quad R_{th(J-A)} = 10+1.2+1.5+16.7 = 29.4\text{ }^{\circ}\text{C/W}$$

$$\text{If Area is } 60\text{cm}^2 \quad R_{th}=8.3 \quad R_{th(J-A)} = 10+1.2+1.5+8.3 = 21^{\circ}\text{C/W}$$

$$\text{If Area is } 90\text{cm}^2 \quad R_{th}=5.5 \quad R_{th(J-A)} = 10+1.2+1.5+5.5 = 18.2^{\circ}\text{C/W}$$

Junction Temperature Calculation

The total power dissipated by the LED is the product of the forward voltage (V_F) and the forward current (I_F) of the LED.

The temperature of the LED junction is the sum of the ambient temperature and the product of the thermal resistance from junction to ambient and the power dissipated.

$$T_{\text{Junction}} = T_{\text{Air}} + R_{th(J-A)} \times P_{\text{Dissipation}}$$

If one white Edixeon[®] in room temperature (25°C) operated 350mA and $V_F=3.3\text{V}$, the $P_{\text{Dissipation}}=0.35 \times 3.3=1.155\text{W}$

And junction temperature is

$$T_{\text{Junction}} = 25^{\circ}\text{C} + 18.2 \times 1.155 = 46.021^{\circ}\text{C} \quad (\text{total surface area} = 90\text{cm}^2)$$

$$T_{\text{Junction}} = 25^{\circ}\text{C} + 21 \times 1.155 = 49.255^{\circ}\text{C} \quad (\text{total surface area} = 60\text{cm}^2)$$

$$T_{\text{Junction}} = 25^{\circ}\text{C} + 29.4 \times 1.155 = 58.957^{\circ}\text{C} \quad (\text{total surface area} = 30\text{cm}^2)$$

Example : Junction Temperature Calculation

One white LED is used under ambient temperature (T_{Ambient}) of 30°C . This LED is soldered on MCPCB (Area= 10cm^2). Calculate junction temperature.

Assuming a forward voltage of $V_F=3.3\text{V}$ at 350mA and total power dissipated is

$$P_{\text{Dissipation}} = 1 \times 0.35 \times 3.3 = 1.155\text{ W.}$$

$$\text{LED } R_{th(J-S)} = 10^{\circ}\text{C/W.}$$

With good design, $R_{th(S-G)}$ can be minimized to 1°C/W .

$R_{th(G-B)}$ of a standard MCPCB can be 1.5°C/W .

The R_{th} between board and air is mainly dependent on the total surface area.

$$\frac{500}{\text{Area}(\text{cm})^2}$$

Therefore it can be calculated in formula

$$R_{th(B-A)} = \frac{500}{10} = 50 \text{ } ^\circ\text{C/W.}$$

Following the formula $T_{\text{Junction}} = T_{\text{Ambient}} + R_{th(J-A)} \times P_{\text{Dissipation}}$

$$T_{\text{Junction}} = 30 \text{ } ^\circ\text{C} + (10 \text{ } ^\circ\text{C/W} + 1 \text{ } ^\circ\text{C/W} + 1.5 \text{ } ^\circ\text{C/W} + 50 \text{ } ^\circ\text{C/W}) \times 1.155\text{W}$$
$$= 102.1875 \text{ } ^\circ\text{C}$$

That means this LED emitter is operated under good condition ($T_{\text{Junction}} < 125 \text{ } ^\circ\text{C}$).

It's strongly recommended to keep the junction temperature under $125 \text{ } ^\circ\text{C}$

Or keep the temperature of emitter lead not exceed $55 \text{ } ^\circ\text{C}$

Product Electrical Application Information

Following graphs and descriptions show how to connect LED or LED module and plug to AC outlet.

Step1: Connect the wires of LED Module to the DC output of the driver.

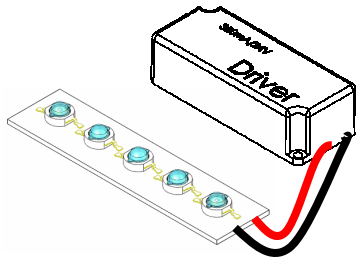

<Figure 28. LED Module connect to the DC output of the driver>

Step2 : Plug the driver to AC outlet.

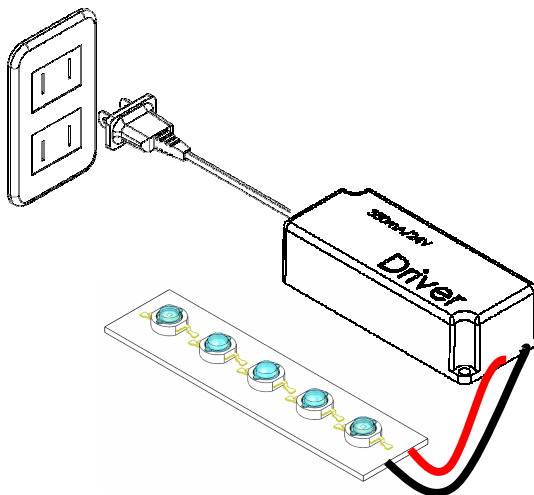

<Figure 29. Plug the AC output of the driver to AC outlet>

Caution: Never plug the driver to AC outlet before the LED Module is properly connected as this may generate transient voltage damage the LEDs permanently with a short or open circuit.

Product Packaging Information

Package Specifications

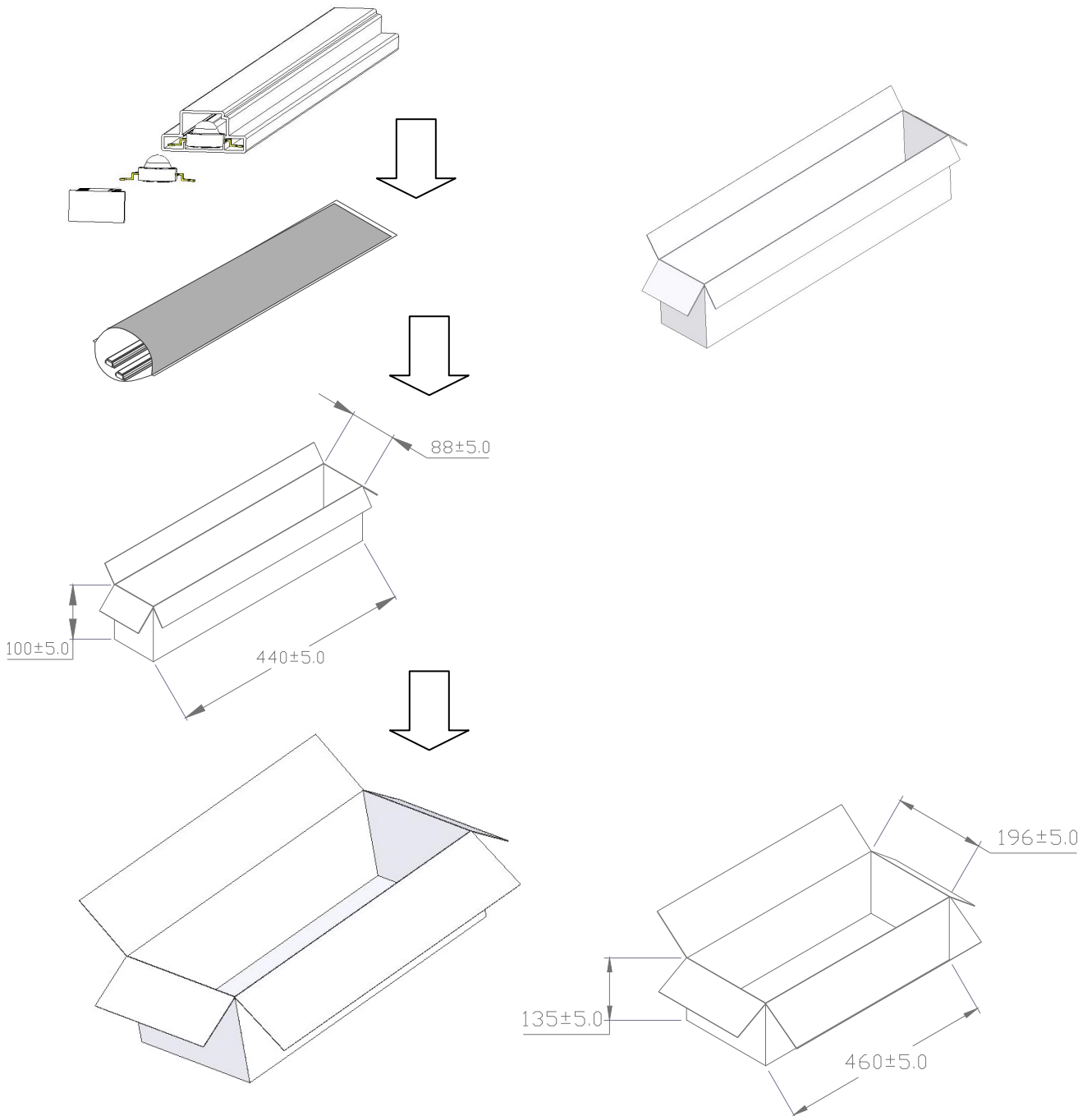

<Figure 30. Package steps and dimensions >

Label

Label on tube :

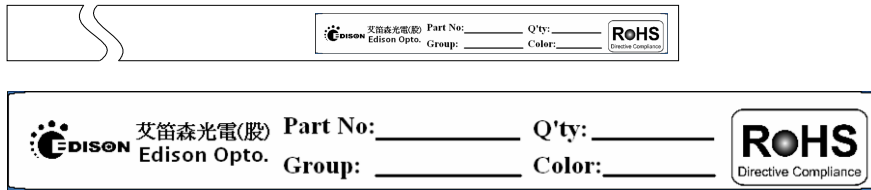

<Figure 31 Label on tube >

Label on inner box :

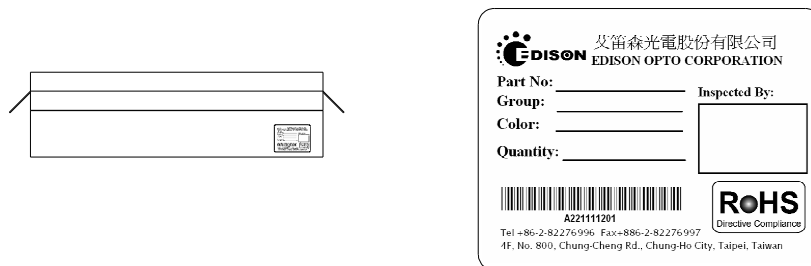

<Figure 32 Label on inner box >

Label on outer box :

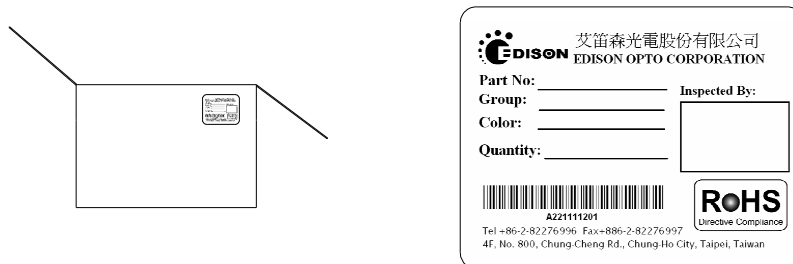

<Figure 33 Label on outer box>

Notes:

1. All dimensions are in mm.
2. There are 50pcs emitters in a tube
3. There are 20 tubes in a bag.
4. There are 2 bags in a inner box
5. A bag contains one humidity indicator card and drying agent

Star Product Packaging Information

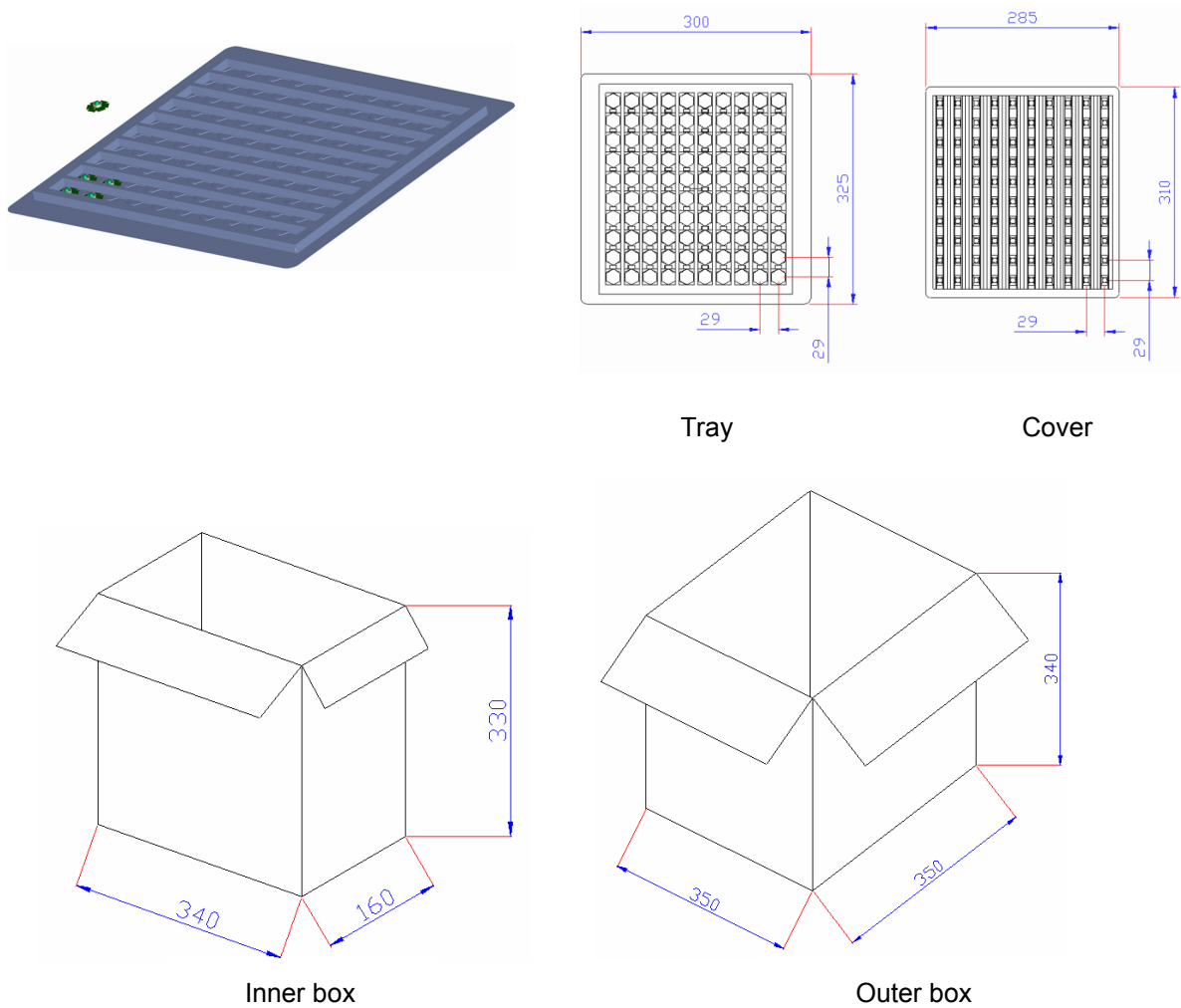

<Figure 34 Edixeon[®] star package and dimensions >

Notes:

1. All dimensions are in mm.
2. There are 100 pcs stars in a tray.(Tray+Cover)
3. There are 10 trays in an inner box.
4. There are 2 inner boxes in an outer box.

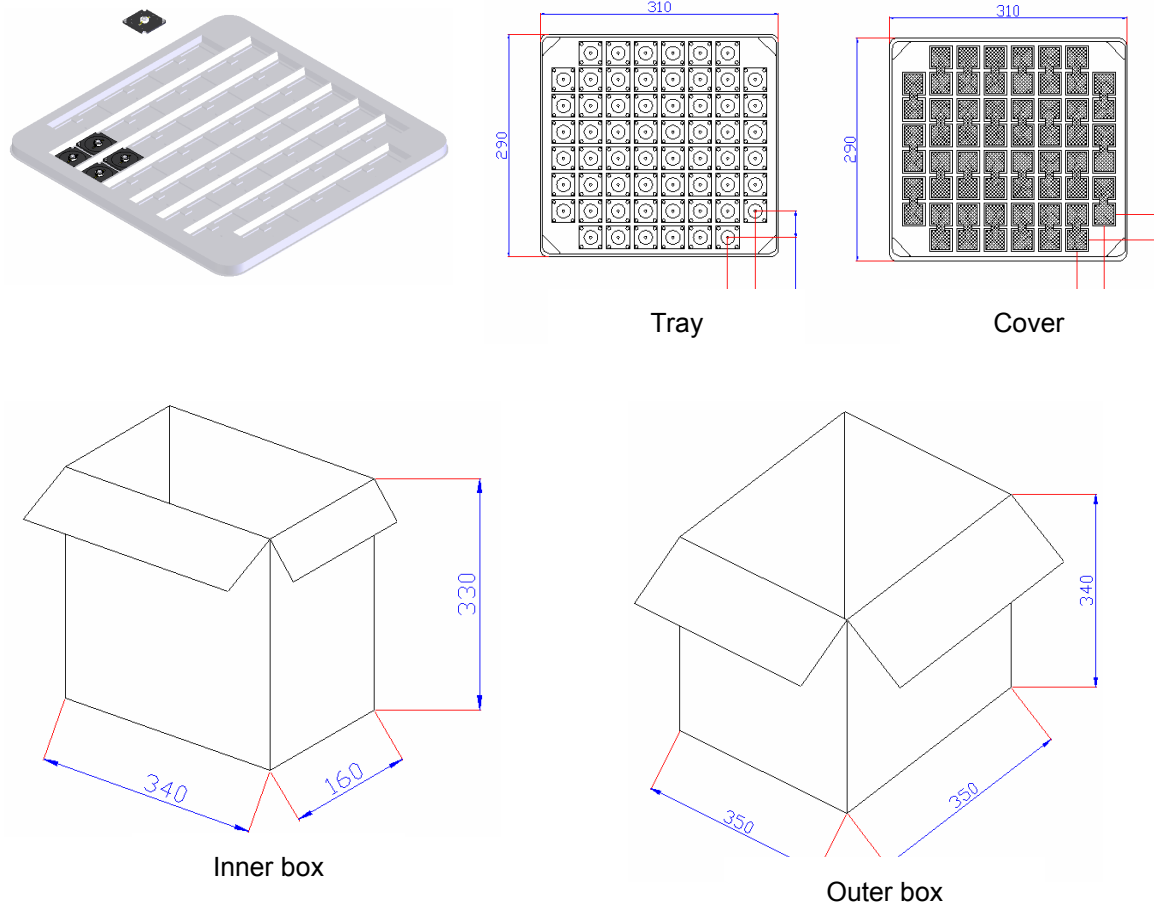

<Figure 35 Edixeon® star package and dimensions >

Notes:

1. All dimensions are in mm.
2. There are 60 pcs stars in a tray.(Tray+Cover)
3. There are 10 trays in an inner box.
4. There are 2 inner boxes in an outer box.